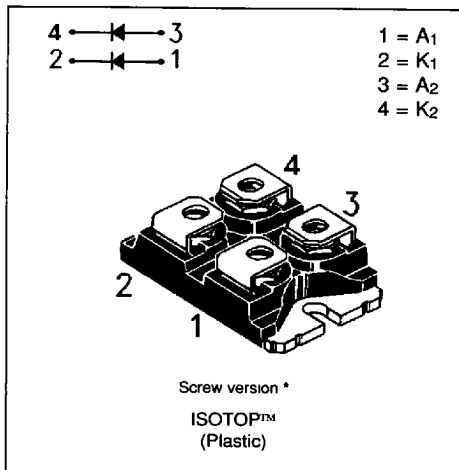

POWER SCHOTTKY RECTIFIER
FEATURES

- VERY SMALL CONDUCTION LOSSES
- NEGLIGIBLE SWITCHING LOSSES
- LOW FORWARD VOLTAGE DROP
- LOW THERMAL RESISTANCE
- EXTREMELY FAST SWITCHING
- INSULATED PACKAGE :
 Insulating voltage = 2500 V(RMS)

DESCRIPTION

Dual power schottky rectifier suited for switchmode power supply and high frequency DC to DC converters.

Packaged in ISOTOP™, this device is intended for use in low voltage, high frequency inverters, free wheeling and polarity protection applications.

ABSOLUTE RATINGS (limiting values)

| Symbol | Parameter | | Value | Unit |
|------------------------------------|--|-----------------------|--------------------------------|----------|
| I _F (RMS) | RMS forward current | | Per diode 125 | A |
| I _F (AV) | Average forward current | T _c =85°C | Per diode 80 | A |
| | | δ = 0.5 | Per device 160 | A |
| I _{FSM} | Surge non repetitive forward current | tp=10ms sinusoidal | Per diode 900 | A |
| I _{RRM} | Peak repetitive reverse current | tp=2µs F=1KHz | Per diode 2 | A |
| T _{stg} T _J | Storage and junction temperature range | | - 65 to + 150 - 65 to + 150 | °C °C |
| dV/dt | Critical rate of rise of reverse voltage | | 1000 | V/µs |

| Symbol | Parameter | STPS | | Unit |
|------------------|---------------------------------|---------|---------|------|
| | | 16035TV | 16045TV | |
| V _{RRM} | Repetitive peak reverse voltage | 35 | 45 | V |

* : Tin plated Fast-on version is also available (without V suffix)

TM : ISOTOP is a trademark of SGS-THOMSON Microelectronics

STPS16035T(V) / STPS16045T(V)

THERMAL RESISTANCES

| Symbol | Parameter | | Value | Unit |
|-----------|------------------|-----------|-------|------|
| Rth (j-c) | Junction to case | Per diode | 0.9 | °C/W |
| | | Total | 0.5 | |
| Rth (c) | Coupling | | 0.1 | °C/W |

When the diodes 1 and 2 are used simultaneously :

$$\Delta T_j(\text{diode } 1) = P(\text{diode}) \times R_{th}(\text{Per diode}) + P(\text{diode } 2) \times R_{th}(c)$$

ELECTRICAL CHARACTERISTICS (Per diode)

STATIC CHARACTERISTICS

| Symbol | Test Conditions | | Min. | Typ. | Max. | Unit |
|-------------------|------------------------|-----------------------------------|------|------|------|------|
| I _R * | T _j = 25°C | V _R = V _{RRM} | | | 1 | mA |
| | T _j = 125°C | | | | 150 | |
| V _F ** | T _j = 125°C | I _F = 160 A | | | 0.90 | V |
| | T _j = 125°C | I _F = 80 A | | | 0.69 | |
| | T _j = 25°C | I _F = 160 A | | | 0.95 | |

Pulse test : * tp = 5 ms, duty cycle < 2 %

** tp = 380 μs, duty cycle < 2 %

To evaluate the conduction losses use the following equation :

$$P = 0.48 \times I_F(\text{AV}) + 0.00262 \times I_F^2(\text{RMS})$$

Fig.1 : Average forward power dissipation versus average forward current. (Per diode)

Fig.2 : Average current versus case temperature. (duty cycle : 0.5) (Per diode)

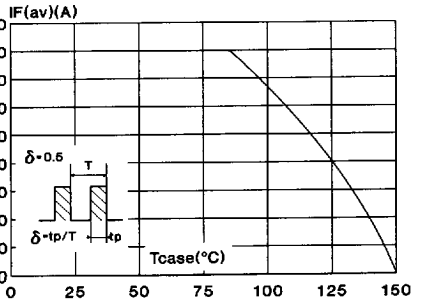
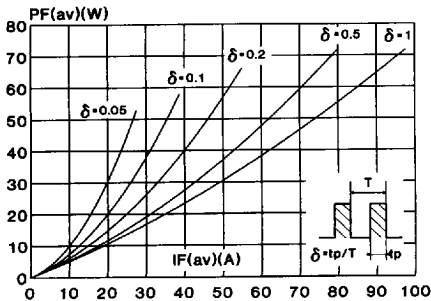

Fig.3 : Non repetitive surge peak forward current versus overload duration. (Maximum values) (Per diode)

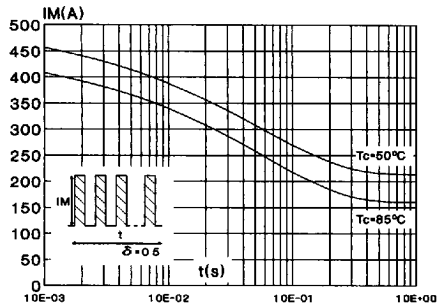

Fig.4 : Relative variation of thermal transient impedance junction to case versus pulse duration.

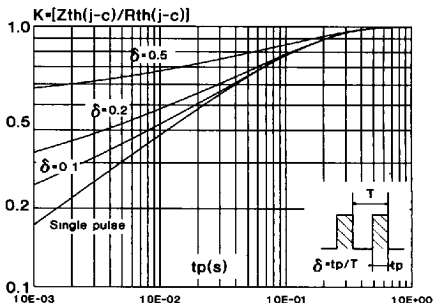

Fig.5 : Reverse leakage current versus reverse voltage applied. (Typical values) (Per diode)

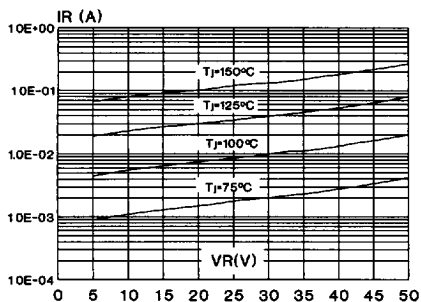

Fig.6 : Junction capacitance versus reverse voltage applied. (Typical values) (Per diode)

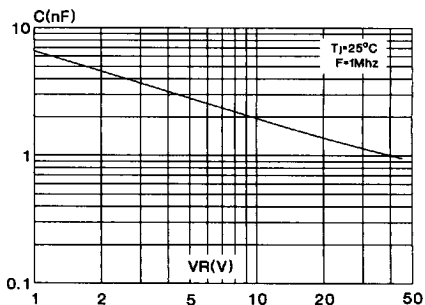

Fig.7 : Forward voltage drop versus forward current. (Maximum values) (Per diode)

